

The Monolith C Series

The Type C series is an ADA-compliant, solid surface sink designed for use with wall-mounted fixtures. This basin style is also available in two, three, or four-user lengths. Optional pipeskirts are available in three finishes.

+ TSL.Mon.C.30



+ TSL.MON.C.30.PS2.BK



+ TSL.MON.C.30.PS2.WH



+ TSL.MON.C.30.PS2.SS



Variant code	Size	Users	Optional pipeskirts	Finish	Fixture holes
TSL.Mon.C.30	30"L x 24"D	One			
TSL.MON.C.30.PS2.SS	30"L x 24"D	One	Straight pipeskirt	Stainless steel	
TSL.MON.C.30.PS2.BK	30"L x 24"D	One	Straight pipeskirt	Black powder coat	
TSL.MON.C.30.PS2.WH	30"L x 24"D	One	Straight pipeskirt	White powder coat	

Technical Data

Sink	100% solid surface (acrylic/resin)
Brackets	Stainless steel
Pipeskirts	Stainless steel (brushed or powder-coated)
Fabrication	Fabricated in Los Angeles and British Columbia by CNC machine with hand-finishing.
Wall construction	Brackets included. Installer should ascertain that wall construction is sufficiently designed to support the Monolith.
Fixed height	See Drawing
Wall Fixings	Must be fixed to a suitable wall substrate to allow for the correct use of the Monolith. The Splash Lab recommend that installers contact a fixings specialist for advice to ensure the correct fixings are used for the location. Wall fixings are not included with the Monolith
Plumbing	Connection to 1 1/4" waste outlet required. (one connection per user) Installer to provide water for taps. See separate data sheet for The Splash Lab sensor taps.
Access requirements	Solenoid and isolation valves must be accessible for initial installation & commissioning and for ongoing and routine maintenance

Installation requirements

ADA	Follow ADA basin height requirements to ensure compliance. One pipeskirt style is available to conceal the pipe system.
Side skirts	Optional caps for pipeskirts where sink is installed with exposed sides.

Compliance & certificates

IPC 2009, 2012, 2015,2018, 2021 IRC 2009, 2012, 2015,2018

UPC 2009, 2102, 2015, 2018, 2021 NPC 2005, 2010. 2015

CSA B45.5 / IAPMO Z124-2107 ADA

LEED

Included

Monolith basin

Angled mounting bracket

Drainage funnel

Drainage funnel gasket

Drainage funnel screws (M6 x 12 screw and washer)

Mounting bolts 1/4-20 UNC x 3/4"

Lock nuts 1/4-20 UNC

Washers

Not included

Wall-mounted fixtures

Drainage connection pipe

Warranty

10 years on solid surface

+ Technical drawing

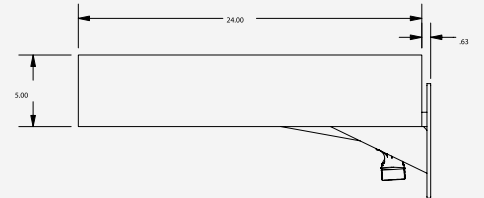
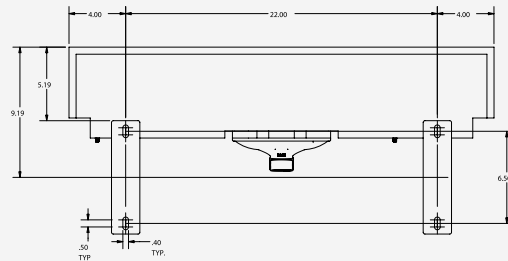
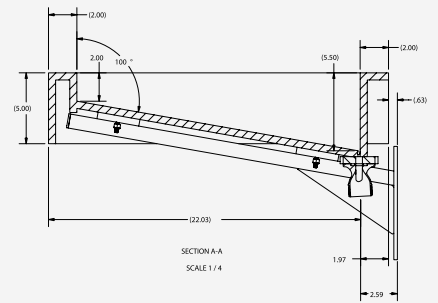
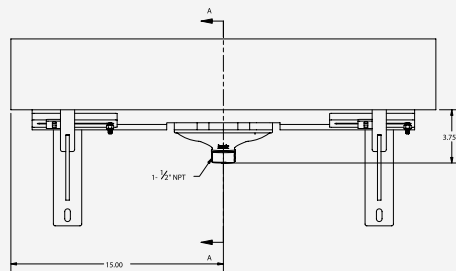
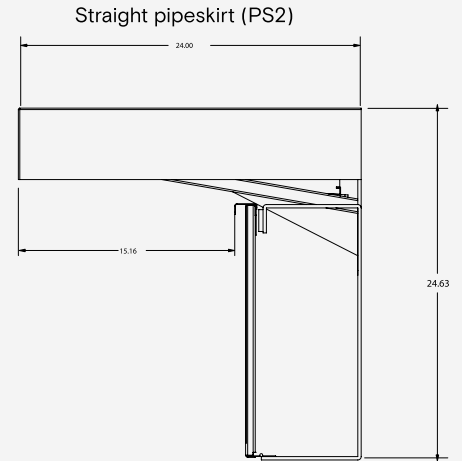
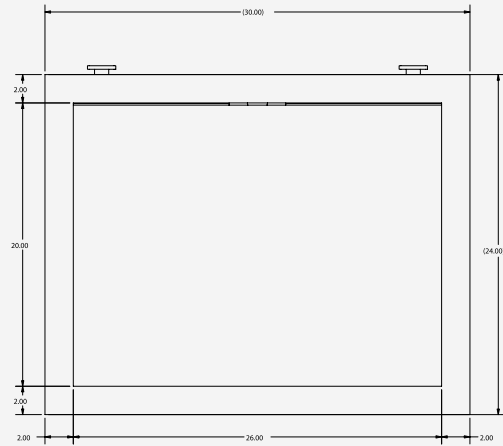

Spare parts

If a situation arises where you require replacement components outside of a maintenance contract, there may be provision to obtain spare parts. Providing the components are under warranty and the parts have become non-functioning during normal use within their assumed usable life, they may be replaced. Should a replacement mains power supply be required it is imperative that an identical type is used. Contact **The Splash Lab** for further information.

Related products



The Channel Soap Dispenser
TSL.C.040

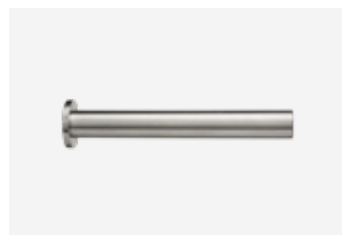

The Channel Hand Dryer
TSL.C.060



The Monolith D Series
TSL.MON.D