

The Monolith B Series

The Type B series is an ADA-compliant, solid surface sink designed for use with deck-mounted fixtures. The basin includes a 12" countertop. This basin style is also available in two, three, or four-user lengths, with individual basins separated by a 12" countertop. Optional pipeskirts are available in three finishes.

+ TSL.MON.B.38.1



+ TSL.MON.B.38.PS1.BK.1



+ TSL.MON.B.38.PS1.WH.1



+ TSL.MON.B.38.PS2.SS.1



+ TSL.MON.B.38.PS2.WH.1



+ TSL.MON.B.38.PS2.BK.1



+ TSL.MON.B.38.PS1.SS.1



Variant code	Size	Users	Optional pipeskirts	Finish	Fixture holes
TSL.MON.B.38.1	38"L x 24"D	One			One
TSL.MON.B.38.2	38"L x 24"D	One			Two
TSL.MON.B.38.3	38"L x 24"D	One			Three
TSL.MON.B.38.PS1.SS.1	38"L x 24"D	One	Angled pipeskirt	Stainless steel	One
TSL.MON.B.38.PS1.BK.1	38"L x 24"D	One	Angled pipeskirt	Black powder coat	One
TSL.MON.B.38.PS1.WH.1	38"L x 24"D	One	Angled pipeskirt	White powder coat	One
TSL.MON.B.38.PS2.SS.1	38"L x 24"D	One	Straight pipeskirt	Stainless steel	One
TSL.MON.B.38.PS2.BK.1	38"L x 24"D	One	Straight pipeskirt	Black powder coat	One
TSL.MON.B.38.PS2.WH.1	38"L x 24"D	One	Straight pipeskirt	White powder coat	One
TSL.MON.B.38.PS1.SS.2	38"L x 24"D	One	Angled pipeskirt	Stainless steel	Two
TSL.MON.B.38.PS1.BK.2	38"L x 24"D	One	Angled pipeskirt	Black powder coat	Two
TSL.MON.B.38.PS1.WH.2	38"L x 24"D	One	Angled pipeskirt	White powder coat	Two
TSL.MON.B.38.PS2.SS.2	38"L x 24"D	One	Straight pipeskirt	Stainless steel	Two
TSL.MON.B.38.PS2.BK.2	38"L x 24"D	One	Straight pipeskirt	Black powder coat	Two
TSL.MON.B.38.PS2.WH.2	38"L x 24"D	One	Straight pipeskirt	White powder coat	Two
TSL.MON.B.38.PS1.SS.1	38"L x 24"D	One	Angled pipeskirt	Stainless steel	Three
TSL.MON.B.38.PS1.BK.1	38"L x 24"D	One	Angled pipeskirt	Black powder coat	Three
TSL.MON.B.38.PS1.WH.1	38"L x 24"D	One	Angled pipeskirt	White powder coat	Three
TSL.MON.B.38.PS2.SS.1	38"L x 24"D	One	Straight pipeskirt	Stainless steel	Three
TSL.MON.B.38.PS2.BK.1	38"L x 24"D	One	Straight pipeskirt	Black powder coat	Three
TSL.MON.B.38.PS2.WH.1	38"L x 24"D	One	Straight pipeskirt	White powder coat	Three

Technical Data

Sink	100% solid surface (acrylic/resin)
Brackets	Stainless steel
Pipeskirts	Stainless steel (brushed or powder-coated)
Fabrication	Fabricated in Los Angeles and British Columbia by CNC machine with hand-finishing.
Wall construction	Brackets included. Installer should ascertain that wall construction is sufficiently designed to support the Monolith.
Fixed height	See Drawing
Wall Fixings	Must be fixed to a suitable wall substrate to allow for the correct use of the Monolith. The Splash Lab recommend that installers contact a fixings specialist for advice to ensure the correct fixings are used for the location. Wall fixings are not included with the Monolith
Plumbing	Connection to 1 ¼" waste outlet required. (one connection per user) Installer to provide water for taps. See separate data sheet for The Splash Lab sensor taps.
Access requirements	Solenoid and isolation valves must be accessible for initial installation & commissioning and for ongoing and routine maintenance

Installation requirements

ADA

Follow ADA basin height requirements to ensure compliance. Two pipeskirt styles are available to conceal the pipe system.

Side skirts

Optional caps for pipeskirts where sink is installed with exposed sides.

Compliance & certificates

IPC 2009, 2012, 2015,2018, 2021 IRC 2009, 2012, 2015,2018

UPC 2009, 2102, 2015, 2018, 2021 NPC 2005, 2010. 2015

CSA B45.5 / IAPMO Z124-2107 ADA

LEED

Continued on next page

Included

- Monolith basin
- Straight mounting bracket
- Drainage funnel
- Drainage funnel gasket
- Drainage funnel screws (M6 x 12 screw and washer)
- Mounting bolts 1/4-20 UNC x 3/4"
- Lock nuts 1/4-20 UNC
- Washers

Not included

- Deck-mounted fixtures
- Drainage connection pipe

Warranty

10 years on solid surface

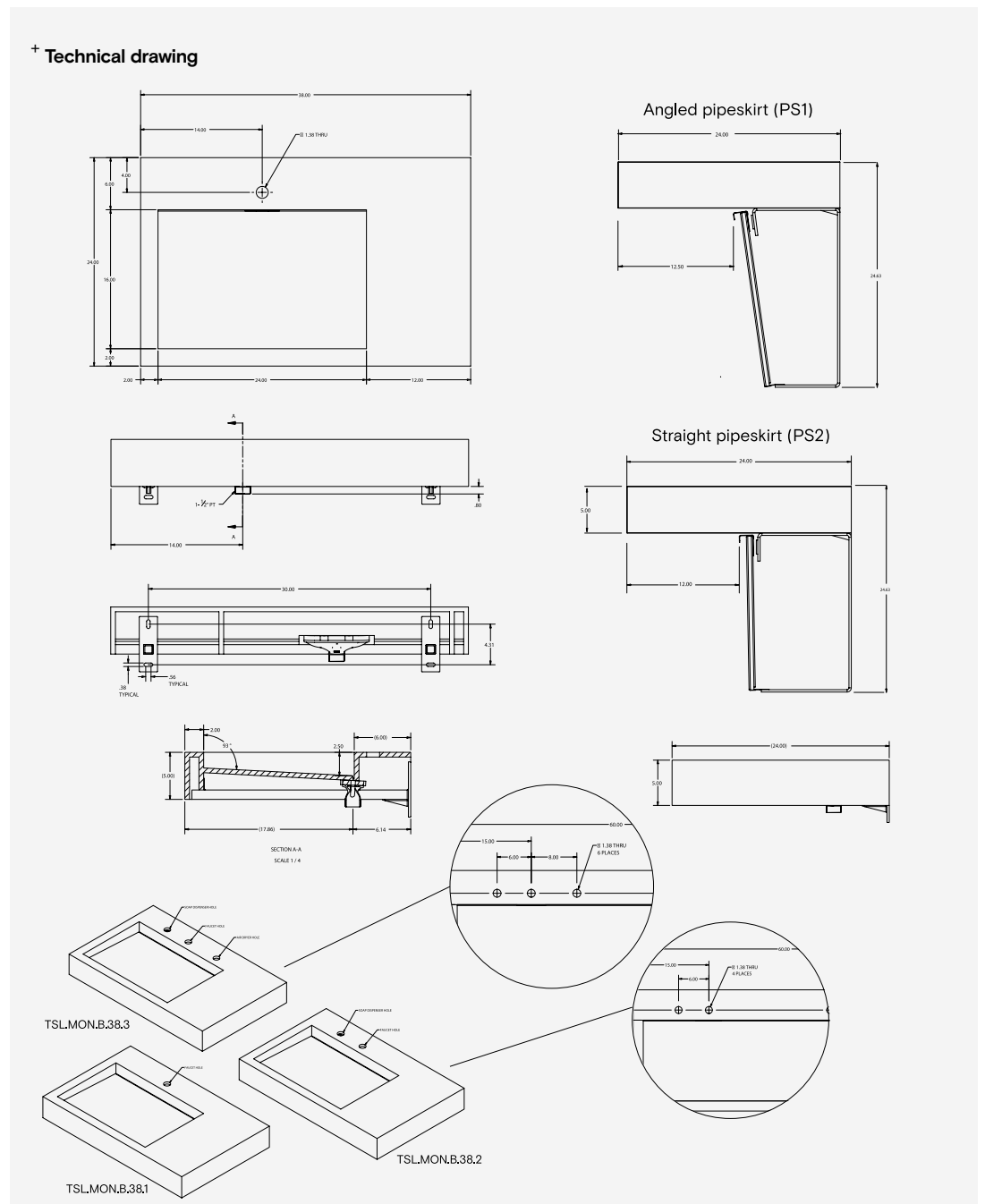

Spare parts

If a situation arises where you require replacement components outside of a maintenance contract, there may be provision to obtain spare parts. Providing the components are under warranty and the parts have become non-functioning during normal use within their assumed usable life, they may be replaced. Should a replacement mains power supply be required it is imperative that an identical type is used. Contact **The Splash Lab** for further information.

Related products



The Ribbon Faucet
TSL.R.020.CS



The Monolith A Series
TSL.MON.A



The Monolith C Series
TSL.MON.C

The Monolith B Series

The Type B series is an ADA-compliant, solid surface sink designed for use with deck-mounted fixtures. The basin includes a 12" countertop divider between each user station. This basin style is also available in one, three, or four-user lengths. Optional pipeskirts are available in three finishes.

+ TSL.MON.B.64.1



+ TSL.MON.B.64.PS1.BK.1

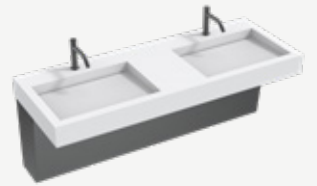

+ TSL.MON.B.64.PS1.WH.1

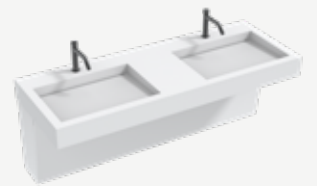

+ TSL.MON.B.64.PS2.SS.1

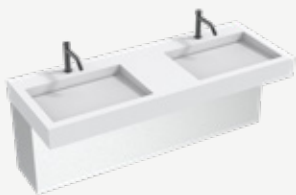

+ TSL.MON.B.64.PS2.WH.1

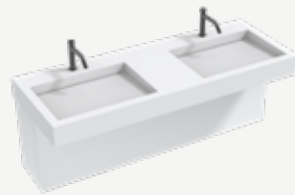

+ TSL.MON.B.64.PS2.BK.1

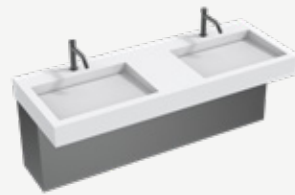

+ TSL.MON.B.64.PS1.SS.1

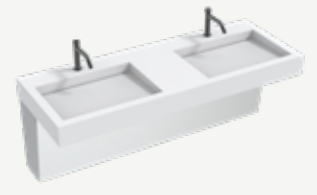

Variant code	Size	Users	Optional pipeskirts	Finish	Fixture holes
TSL.MON.B.64.1	64"L x 24"D	Two			One
TSL.MON.B.64.2	64"L x 24"D	Two			Two
TSL.MON.B.64.3	64"L x 24"D	Two			Three
TSL.MON.B.64.PS1.SS.1	64"L x 24"D	Two	Angled pipeskirt	Stainless steel	One
TSL.MON.B.64.PS1.BK.1	64"L x 24"D	Two	Angled pipeskirt	Black powder coat	One
TSL.MON.B.64.PS1.WH.1	64"L x 24"D	Two	Angled pipeskirt	White powder coat	One
TSL.MON.B.64.PS2.SS.1	64"L x 24"D	Two	Straight pipeskirt	Stainless steel	One
TSL.MON.B.64.PS2.BK.1	64"L x 24"D	Two	Straight pipeskirt	Black powder coat	One
TSL.MON.B.64.PS2.WH.1	64"L x 24"D	Two	Straight pipeskirt	White powder coat	One
TSL.MON.B.64.PS1.SS.2	64"L x 24"D	Two	Angled pipeskirt	Stainless steel	Two
TSL.MON.B.64.PS1.BK.2	64"L x 24"D	Two	Angled pipeskirt	Black powder coat	Two
TSL.MON.B.64.PS1.WH.2	64"L x 24"D	Two	Angled pipeskirt	White powder coat	Two
TSL.MON.B.64.PS2.SS.2	64"L x 24"D	Two	Straight pipeskirt	Stainless steel	Two
TSL.MON.B.64.PS2.BK.2	64"L x 24"D	Two	Straight pipeskirt	Black powder coat	Two
TSL.MON.B.64.PS2.WH.2	64"L x 24"D	Two	Straight pipeskirt	White powder coat	Two
TSL.MON.B.64.PS1.SS.3	64"L x 24"D	Two	Angled pipeskirt	Stainless steel	Three
TSL.MON.B.64.PS1.BK.3	64"L x 24"D	Two	Angled pipeskirt	Black powder coat	Three
TSL.MON.B.64.PS1.WH.3	64"L x 24"D	Two	Angled pipeskirt	White powder coat	Three
TSL.MON.B.64.PS2.SS.3	64"L x 24"D	Two	Straight pipeskirt	Stainless steel	Three
TSL.MON.B.64.PS2.BK.3	64"L x 24"D	Two	Straight pipeskirt	Black powder coat	Three
TSL.MON.B.64.PS2.WH.3	64"L x 24"D	Two	Straight pipeskirt	White powder coat	Three

Technical Data

Sink	100% solid surface (acrylic/resin)
Brackets	Stainless steel
Pipeskirts	Stainless steel (brushed or powder-coated)
Fabrication	Fabricated in Los Angeles and British Columbia by CNC machine with hand-finishing.
Wall construction	Brackets included. Installer should ascertain that wall construction is sufficiently designed to support the Monolith.
Fixed height	See Drawing
Wall Fixings	Must be fixed to a suitable wall substrate to allow for the correct use of the Monolith. The Splash Lab recommend that installers contact a fixings specialist for advice to ensure the correct fixings are used for the location. Wall fixings are not included with the Monolith
Plumbing	Connection to 1 ¼" waste outlet required. (one connection per user) Installer to provide water for taps. See separate data sheet for The Splash Lab sensor taps.
Access requirements	Solenoid and isolation valves must be accessible for initial installation & commissioning and for ongoing and routine maintenance

Installation requirements

ADA	Follow ADA basin height requirements to ensure compliance. Two pipeskirt styles are available to conceal the pipe system.
Side skirts	Optional caps for pipeskirts where sink is installed with exposed sides.

Compliance & certificates

IPC 2009, 2012, 2015,2018, 2021 IRC 2009, 2012, 2015,2018

UPC 2009, 2102, 2015, 2018, 2021 NPC 2005, 2010. 2015

CSA B45.5 / IAPMO Z124-2107 ADA

LEED

Continued on next page

Included

- Monolith basin
- Straight mounting bracket
- Drainage funnel
- Drainage funnel gasket
- Drainage funnel screws (M6 x 12 screw and washer)
- Mounting bolts 1/4-20 UNC x 3/4"
- Lock nuts 1/4-20 UNC
- Washers

Not included

- Deck-mounted fixtures
- Drainage connection pipe

Warranty

10 years on solid surface

+ Technical drawing

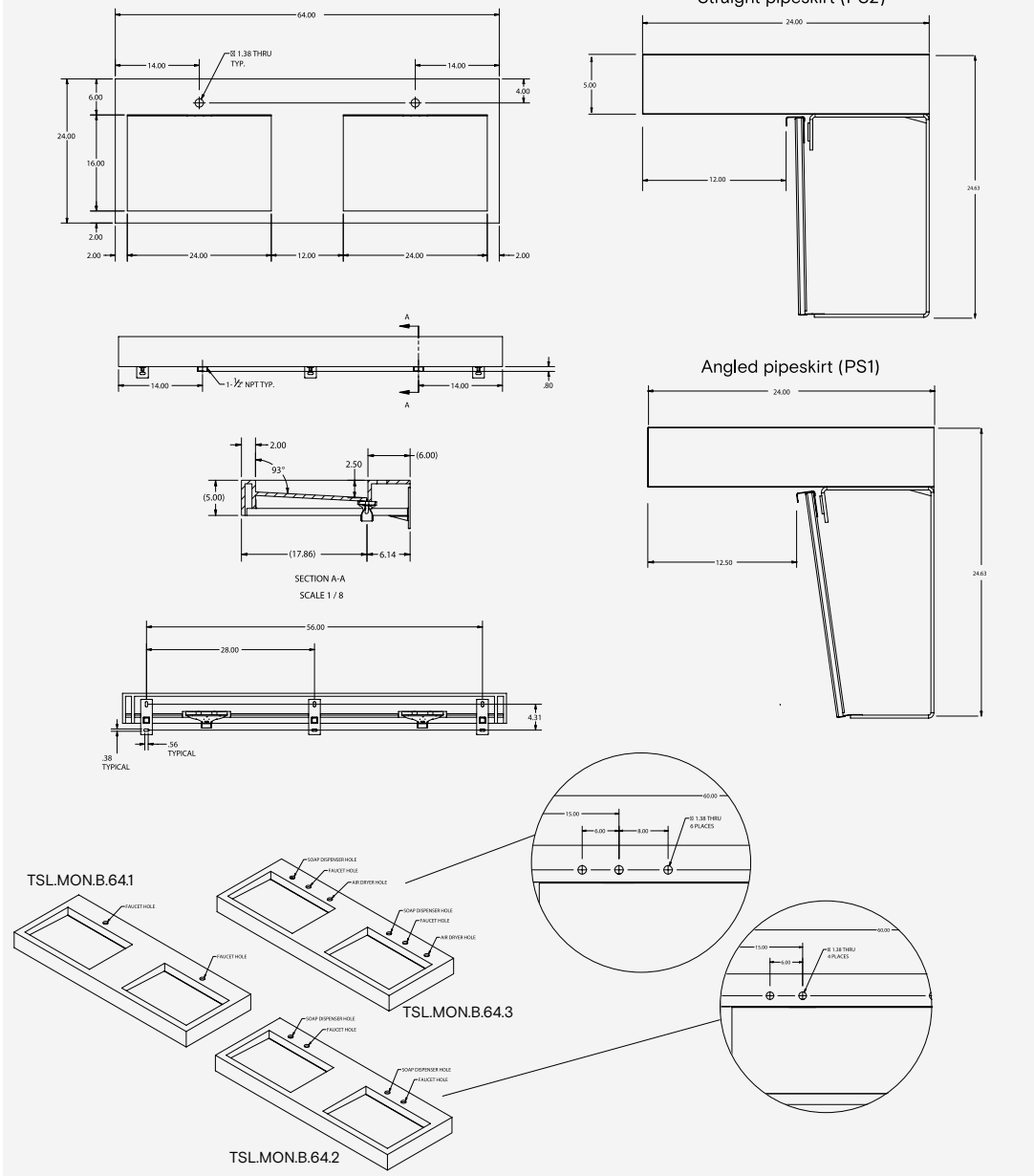

Spare parts

If a situation arises where you require replacement components outside of a maintenance contract, there may be provision to obtain spare parts. Providing the components are under warranty and the parts have become non-functioning during normal use within their assumed usable life, they may be replaced. Should a replacement mains power supply be required it is imperative that an identical type is used. Contact **The Splash Lab** for further information.

Related products



The Ribbon Faucet
TSL.R.020.CS



The Monolith A Series
TSL.MON.A



The Monolith C Series
TSL.MON.C

The Monolith B Series

The Type B series is an ADA-compliant, solid surface sink designed for use with deck-mounted fixtures. The basin includes a 12" countertop divider between each user station. This basin style is also available in one, two, or four-user lengths. Optional pipeskirts are available in three finishes.

+ TSL.Mon.B.100.1

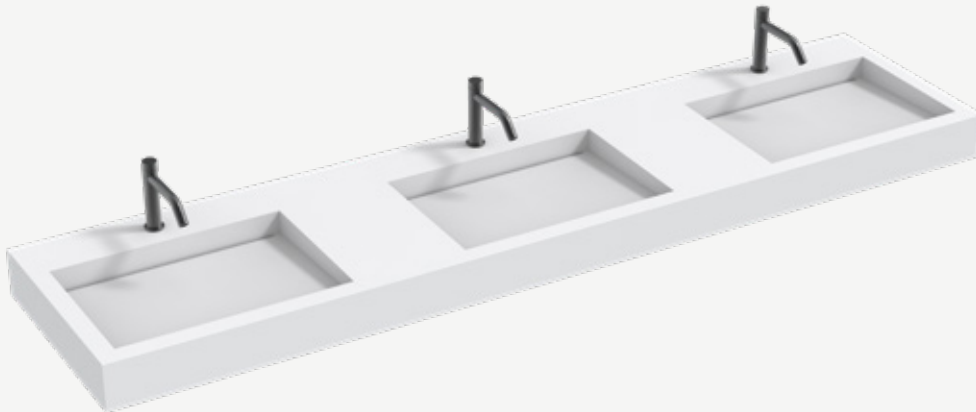

+ TSL.MON.B.100.PS1.BK.1

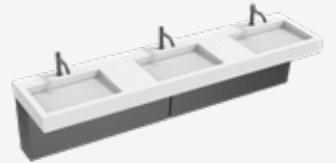

+ TSL.MON.B.100.PS1.WH.1

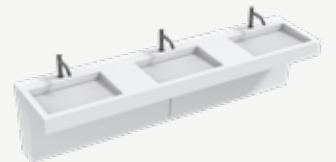

+ TSL.MON.B.100.PS2.SS.1

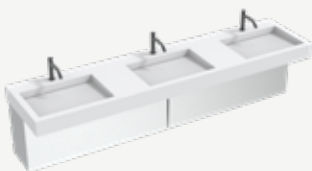

+ TSL.MON.B.100.PS2.WH.1

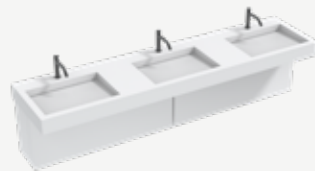

+ TSL.MON.B.100.PS2.BK.1

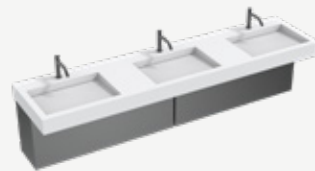

+ TSL.MON.B.100.PS1.SS.1

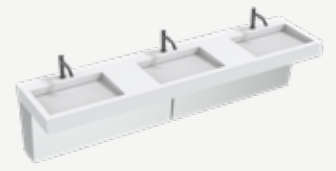

Variant code	Size	Users	Optional pipeskirts	Finish	Fixture holes
TSL.MON.B.100.1	100"L x 24"D	Three			One
TSL.MON.B.100.2	100"L x 24"D	Three			Two
TSL.MON.B.100.3	100"L x 24"D	Three			Three
TSL.MON.B.100.PS1.SS.1	100"L x 24"D	Three	Angled pipeskirt	Stainless steel	One
TSL.MON.B.100.PS1.BK.1	100"L x 24"D	Three	Angled pipeskirt	Black powder coat	One
TSL.MON.B.100.PS1.WH.1	100"L x 24"D	Three	Angled pipeskirt	White powder coat	One
TSL.MON.B.100.PS2.SS.1	100"L x 24"D	Three	Straight pipeskirt	Stainless steel	One
TSL.MON.B.100.PS2.BK.1	100"L x 24"D	Three	Straight pipeskirt	Black powder coat	One
TSL.MON.B.100.PS2.WH.1	100"L x 24"D	Three	Straight pipeskirt	White powder coat	One
TSL.MON.B.100.PS1.SS.2	100"L x 24"D	Three	Angled pipeskirt	Stainless steel	Two
TSL.MON.B.100.PS1.BK.2	100"L x 24"D	Three	Angled pipeskirt	Black powder coat	Two
TSL.MON.B.100.PS1.WH.2	100"L x 24"D	Three	Angled pipeskirt	White powder coat	Two
TSL.MON.B.100.PS2.SS.2	100"L x 24"D	Three	Straight pipeskirt	Stainless steel	Two
TSL.MON.B.100.PS2.BK.2	100"L x 24"D	Three	Straight pipeskirt	Black powder coat	Two
TSL.MON.B.100.PS2.WH.2	100"L x 24"D	Three	Straight pipeskirt	White powder coat	Two
TSL.MON.B.100.PS1.SS.3	100"L x 24"D	Three	Angled pipeskirt	Stainless steel	Three
TSL.MON.B.100.PS1.BK.3	100"L x 24"D	Three	Angled pipeskirt	Black powder coat	Three
TSL.MON.B.100.PS1.WH.3	100"L x 24"D	Three	Angled pipeskirt	White powder coat	Three
TSL.MON.B.100.PS2.SS.3	100"L x 24"D	Three	Straight pipeskirt	Stainless steel	Three
TSL.MON.B.100.PS2.BK.3	100"L x 24"D	Three	Straight pipeskirt	Black powder coat	Three
TSL.MON.B.100.PS2.WH.3	100"L x 24"D	Three	Straight pipeskirt	White powder coat	Three

Technical Data

Sink	100% solid surface (acrylic/resin)
Brackets	Stainless steel
Pipeskirts	Stainless steel (brushed or powder-coated)
Fabrication	Fabricated in Los Angeles and British Columbia by CNC machine with hand-finishing.
Wall construction	Brackets included. Installer should ascertain that wall construction is sufficiently designed to support the Monolith.
Fixed height	See Drawing
Wall Fixings	Must be fixed to a suitable wall substrate to allow for the correct use of the Monolith. The Splash Lab recommend that installers contact a fixings specialist for advice to ensure the correct fixings are used for the location. Wall fixings are not included with the Monolith
Plumbing	Connection to 1 ¼" waste outlet required. (one connection per user) Installer to provide water for taps. See separate data sheet for The Splash Lab sensor taps.
Access requirements	Solenoid and isolation valves must be accessible for initial installation & commissioning and for ongoing and routine maintenance

Installation requirements

ADA	Follow ADA basin height requirements to ensure compliance. Two pipeskirt styles are available to conceal the pipe system.
Side skirts	Optional caps for pipeskirts where sink is installed with exposed sides.

Compliance & certificates

IPC 2009, 2012, 2015,2018, 2021 IRC 2009, 2012, 2015,2018

UPC 2009, 2102, 2015, 2018, 2021 NPC 2005, 2010. 2015

CSA B45.5 / IAPMO Z124-2107 ADA

LEED

Continued on next page

Included

- _____ Monolith basin
- _____ Straight mounting bracket
- _____ Drainage funnel
- _____ Drainage funnel gasket
- _____ Drainage funnel screws (M6 x 12 screw and washer)
- _____ Mounting bolts 1/4-20 UNC x 3/4"
- _____ Lock nuts 1/4-20 UNC
- _____ Washers

Not included

- _____ Deck-mounted fixtures
- _____ Drainage connection pipe

Warranty

_____ 10 years on solid surface

+ Technical drawing

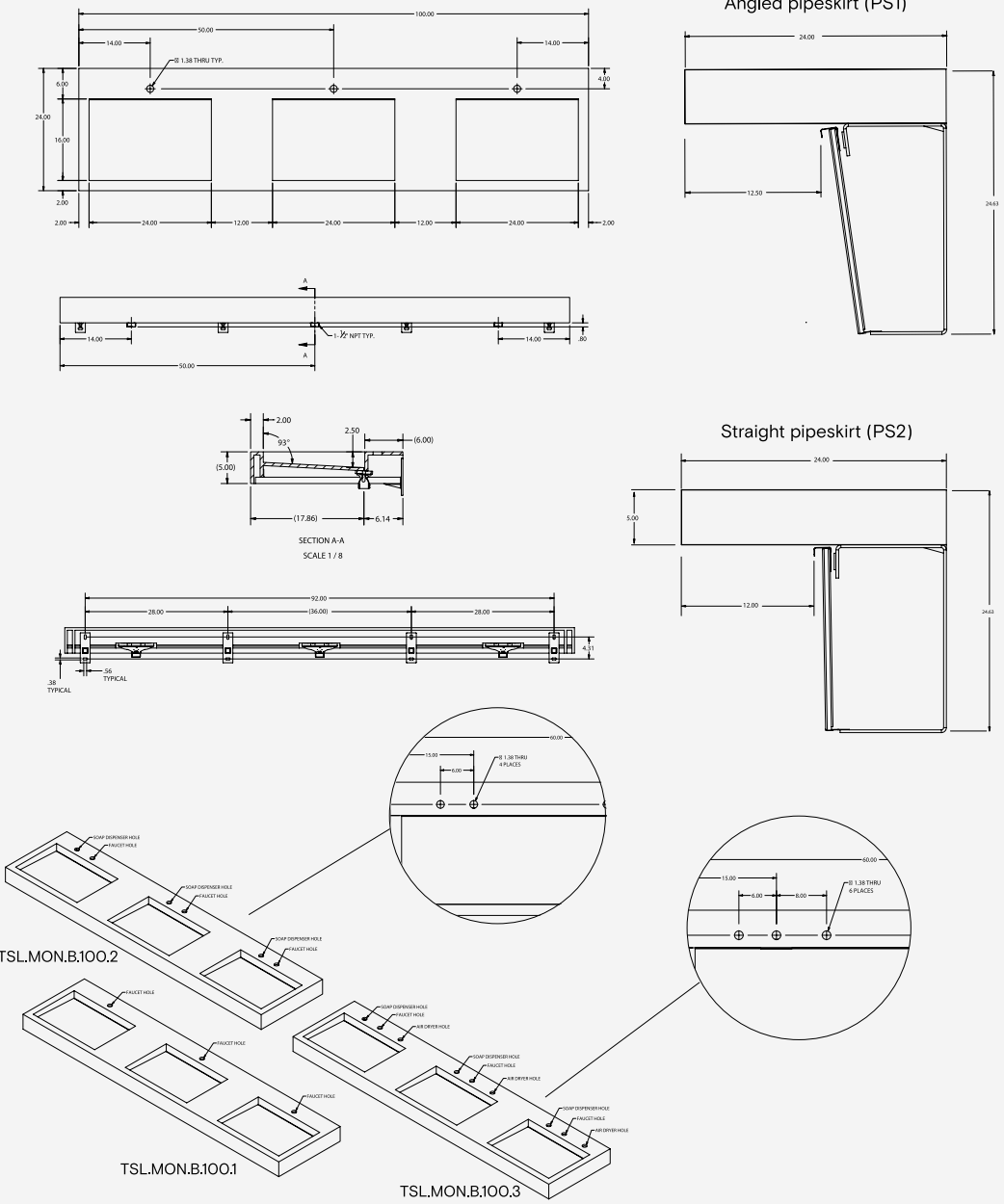

Spare parts

If a situation arises where you require replacement components outside of a maintenance contract, there may be provision to obtain spare parts. Providing the components are under warranty and the parts have become non-functioning during normal use within their assumed usable life, they may be replaced. Should a replacement mains power supply be required it is imperative that an identical type is used. Contact **The Splash Lab** for further information.

Related products



The Ribbon Faucet
TSL.R.020.CS



The Monolith A Series
TSL.MON.A



The Monolith C Series
TSL.MON.C

The Monolith B Series

The Type B series is an ADA-compliant, solid surface sink designed for use with deck-mounted fixtures. The basin includes a 12" countertop divider between each user station. This basin style is also available in one, two, or three-user lengths. Optional pipeskirts are available in three finishes.

+ TSL.MON.B.136.1

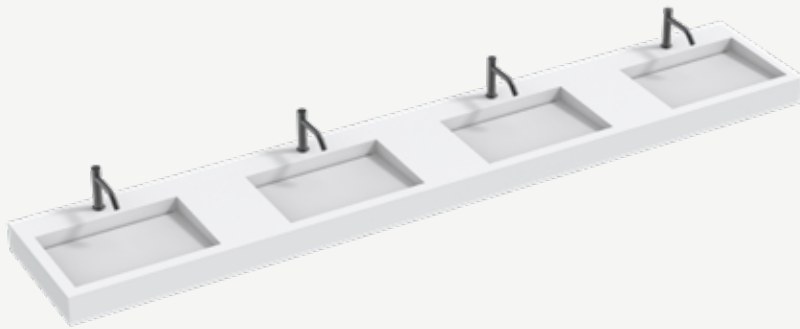

+ TSL.MON.B.136.PS2.BK.1

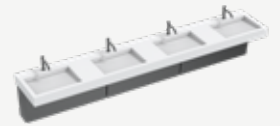

+ TSL.MON.B.136.PS2.WH.1

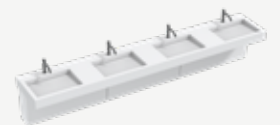

+ TSL.MON.B.136.PS1.BK.1

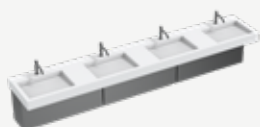

+ TSL.MON.B.136.PS1.WH.1

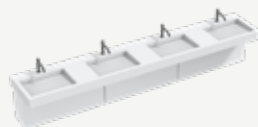

+ TSL.MON.B.136.PS1.SS.1

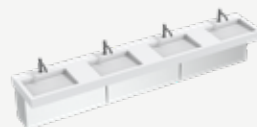

+ TSL.MON.B.136.PS2.SS.1

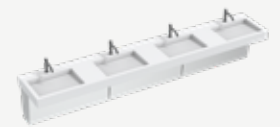

Variant code	Size	Users	Optional pipeskirts	Finish	Fixture holes
TSL.MON.B.64.1	136"L x 24"D	Four			One
TSL.MON.B.64.2	136"L x 24"D	Four			Two
TSL.MON.B.136.3	136"L x 24"D	Four			Three
TSL.MON.B.136.PS2.SS.1	136"L x 24"D	Four	Angled pipeskirt	Stainless steel	One
TSL.MON.B.136.PS2.BK.1	136"L x 24"D	Four	Angled pipeskirt	Black powder coat	One
TSL.MON.B.136.PS2.WH.1	136"L x 24"D	Four	Angled pipeskirt	White powder coat	One
TSL.MON.B.136.PS1.SS.1	136"L x 24"D	Four	Straight pipeskirt	Stainless steel	One
TSL.MON.B.136.PS1.BK.1	136"L x 24"D	Four	Straight pipeskirt	Black powder coat	One
TSL.MON.B.136.PS1.WH.1	136"L x 24"D	Four	Straight pipeskirt	White powder coat	One
TSL.MON.B.136.PS1.SS.2	136"L x 24"D	Four	Angled pipeskirt	Stainless steel	Two
TSL.MON.B.136.PS1.BK.2	136"L x 24"D	Four	Angled pipeskirt	Black powder coat	Two
TSL.MON.B.136.PS1.WH.2	136"L x 24"D	Four	Angled pipeskirt	White powder coat	Two
TSL.MON.B.136.PS2.SS.2	136"L x 24"D	Four	Straight pipeskirt	Stainless steel	Two
TSL.MON.B.136.PS2.BK.2	136"L x 24"D	Four	Straight pipeskirt	Black powder coat	Two
TSL.MON.B.136.PS2.WH.2	136"L x 24"D	Four	Straight pipeskirt	White powder coat	Two
TSL.MON.B.136.PS1.SS.3	136"L x 24"D	Four	Angled pipeskirt	Stainless steel	Three
TSL.MON.B.136.PS1.BK.3	136"L x 24"D	Four	Angled pipeskirt	Black powder coat	Three
TSL.MON.B.136.PS1.WH.3	136"L x 24"D	Four	Angled pipeskirt	White powder coat	Three
TSL.MON.B.136.PS2.SS.3	136"L x 24"D	Four	Straight pipeskirt	Stainless steel	Three
TSL.MON.B.136.PS2.BK.3	136"L x 24"D	Four	Straight pipeskirt	Black powder coat	Three
TSL.MON.B.136.PS2.WH.3	136"L x 24"D	Four	Straight pipeskirt	White powder coat	Three

Technical Data

Sink	100% solid surface (acrylic/resin)
Brackets	Stainless steel
Pipeskirts	Stainless steel (brushed or powder-coated)
Fabrication	Fabricated in Los Angeles and British Columbia by CNC machine with hand-finishing.
Wall construction	Brackets included. Installer should ascertain that wall construction is sufficiently designed to support the Monolith.
Fixed height	See Drawing
Wall Fixings	Must be fixed to a suitable wall substrate to allow for the correct use of the Monolith. The Splash Lab recommend that installers contact a fixings specialist for advice to ensure the correct fixings are used for the location. Wall fixings are not included with the Monolith
Plumbing	Connection to 1 ¼" waste outlet required. (one connection per user) Installer to provide water for taps. See separate data sheet for The Splash Lab sensor taps.
Access requirements	Solenoid and isolation valves must be accessible for initial installation & commissioning and for ongoing and routine maintenance

Installation requirements

ADA

Follow ADA basin height requirements to ensure compliance. Two pipeskirt styles are available to conceal the pipe system.

Side skirts

Optional caps for pipeskirts where sink is installed with exposed sides.

Compliance & certificates

IPC 2009, 2012, 2015,2018, 2021 IRC 2009, 2012, 2015,2018

UPC 2009, 2102, 2015, 2018, 2021 NPC 2005, 2010. 2015

CSA B45.5 / IAPMO Z124-2107 ADA

LEED

Continued on next page

Included

- Monolith basin
- Straight mounting bracket
- Drainage funnel
- Drainage funnel gasket
- Drainage funnel screws (M6 x 12 screw and washer)
- Mounting bolts 1/4-20 UNC x 3/4"
- Lock nuts 1/4-20 UNC
- Washers

Not included

- Deck-mounted fixtures
- Drainage connection pipe

Warranty

10 years on solid surface

+ Technical drawing

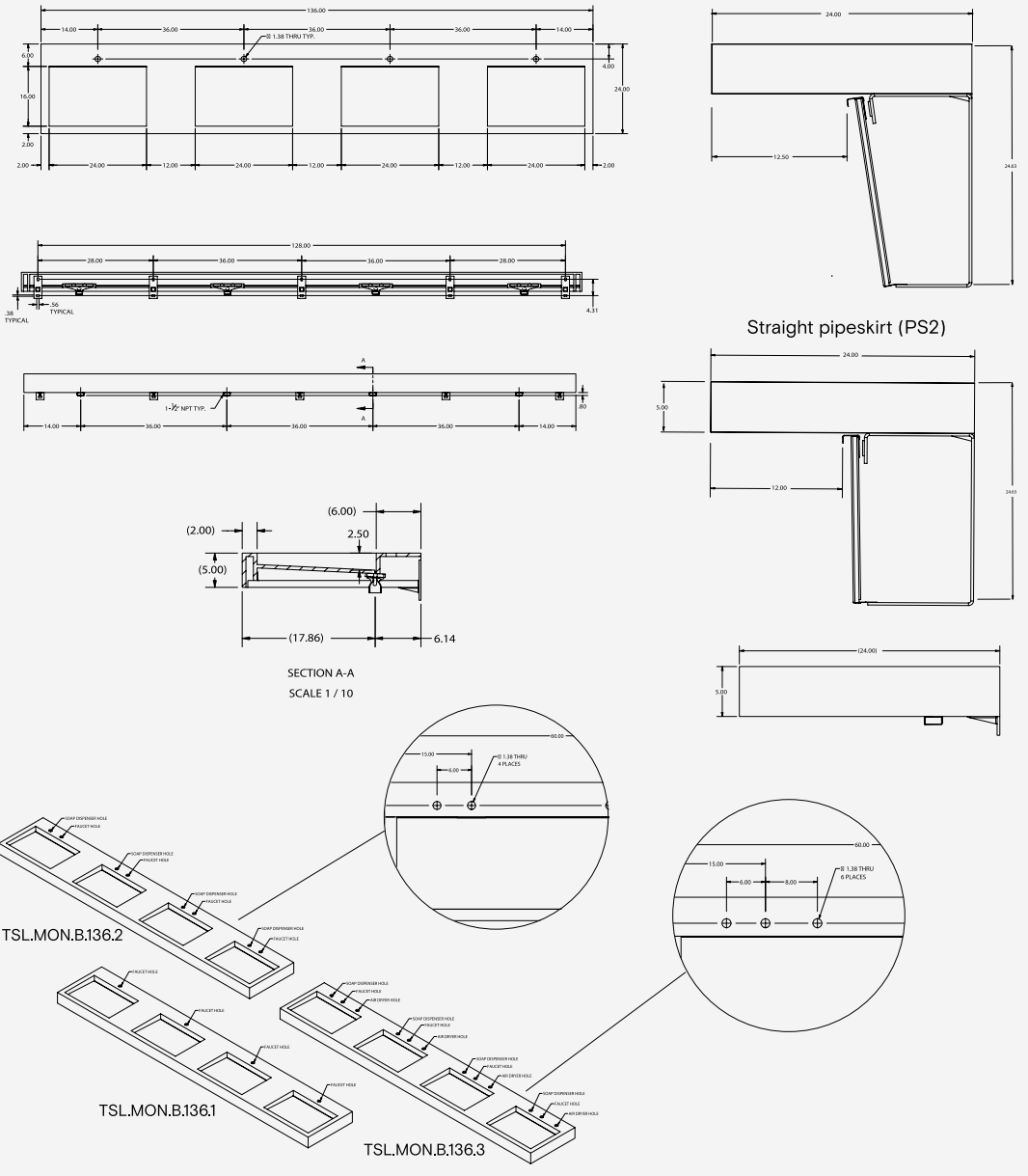

Spare parts

If a situation arises where you require replacement components outside of a maintenance contract, there may be provision to obtain spare parts. Providing the components are under warranty and the parts have become non-functioning during normal use within their assumed usable life, they may be replaced. Should a replacement mains power supply be required it is imperative that an identical type is used. Contact **The Splash Lab** for further information.

Related products



The Ribbon Faucet
TSL.R.020.CS



The Monolith A Series
TSL.MON.A



The Monolith C Series
TSL.MON.C