

The Ribbon Hand Dryer

TSL.R031

With an acoustically insulated and powerful blower unit, the Ribbon Hand Dryer offers a quiet user experience with fast and efficient drying times. Furthermore, with a touch free sink mounted system, there are no longer any drips carried across your washroom floors.

Finish	Codes	LRV*
● Black	TSL.R031.BK	3
● Brass	TSL.R031.BR	40
● Satin	TSL.R031.CS	58
● Bronze	TSL.R031.BZ	17
● Copper	TSL.R031.CP	19
● Chrome	TSL.R031.C	75

Light Reflectance Value*



+ Satin

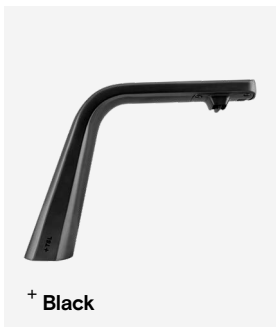

+ Black

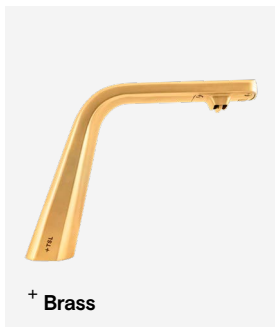

+ Brass

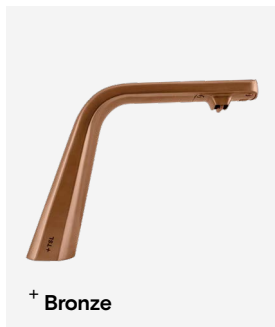

+ Bronze

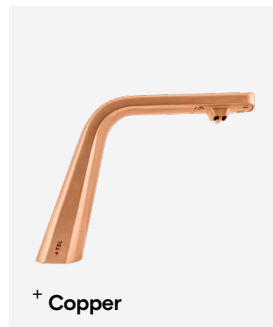

+ Copper

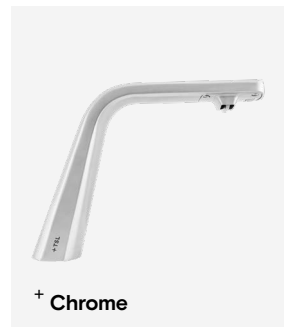

+ Chrome

Technical Data

Voltage	220-240 ac; 50/60Hz
Current draw	3.8-4.2A
Power consumption	0.84-1.0kW
Standby power	0.3-0.4W
Drying time	<15 seconds
Weight	8kg
Material	304 stainless steel
Noise levels	70.6dB
Heating element	500W
Motor type	Brush type; dual ball bearings
Motor power	500-350W
Air speed	84-101 mis
Air flow	54 m3 /h
Sensor range	120±20 mm
Security cut-off time	60 seconds
Motor thermal protection	Auto resetting thermostat set at 95° C
Heater thermal protection	Auto resetting thermostat set at 85° C Thermal cutout fuse set to 142 ° C
Insulation	Class 1
IP rating	IP35
Approvals	CE, UL, cUL, RoHS, ADA
Filter	3M filter assembly (HEPA filter is available for this product, please enquire for technical information)

Installation requirements

Counter-top cut-out (dia)	Ø32mm
Maximum countertop thickness	35mm
Anti-rotation collar	Included
Reflective surfaces	Not to be installed above highly polished basins
Access requirements	Motor to be accessible at all times for servicing
Cabling	8A fused branch circuit is required
Power supply	It is recommended that the sensors are installed on their own circuit to avoid interference from other power demands. (i.e lighting)

Compliance & certificates

CE,

UL

cUL

RoHS

ADA

UKCA

Included

The Ribbon Hand Dryer

Dryer head assembly

Hand dryer motor unit

Power cable

Anti-rotation collar (already installed)

Gasket (already installed)

Anti-rotation washer

Fixing nut

Motor mounting screws

Hex wrench

Air hose

HEPA filter (Optional)

+ Technical drawing

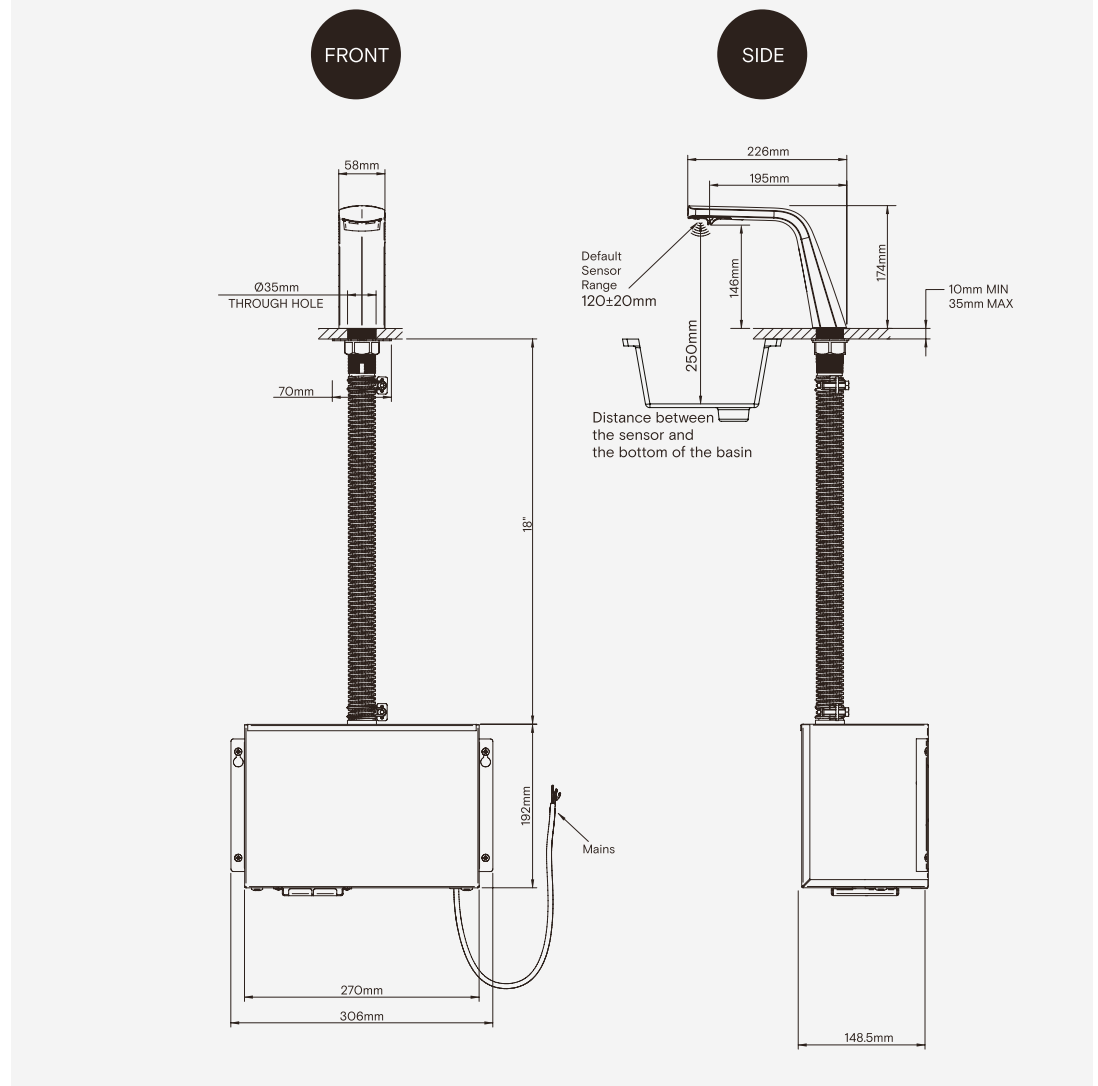

Warranty / Spare parts

For warranty terms and conditions please visit www.thesplashlab.com

If additional spare parts are required and are not listed above, please contact us at info.uk@thesplashlab.com

Related products



The Ribbon Sensor Tap 2.0
TSL.R021



The Ribbon Soap Dispenser
TSL.R011



Air Fury Hand Dryer
TSL.89

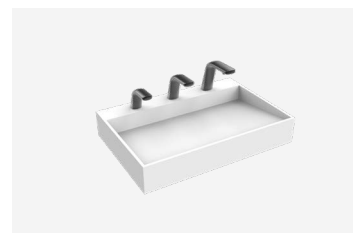

The Ribbon Basin
TSL.R.041